

Volkswagen Crafter 2006 - 02/2017
Mercedes Sprinter 03/2006 -

Partnr.: VW-107-D1U

- Fitting instructions electric wiring kit tow bar with 13-P socket up to DIN/ISO Norm 11446.
- We would expressly point out that assembly not carried out properly by a competent installer will result in cancellation of any right to damage compensation, in particular those arising by virtue of the product liability act.
- Contents of these kits and their fitting manuals are subject to alteration without notice, please ensure that these instructions are read and fully understood before commencing installation.
- Do not overload circuits; the maximum loads per connection are detailed in this manual.
- Attention! Before Installation, please read this manual carefully and inform your customer to consult the vehicle owners manual to check for any vehicle modifications required before towing.
- In the event of functional problems, troubleshooting must be limited to about 0.5 hours, contact the technical support:
ukts@ecs-electronics.com / 07440 202 052.



Part list

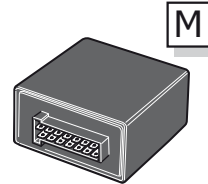
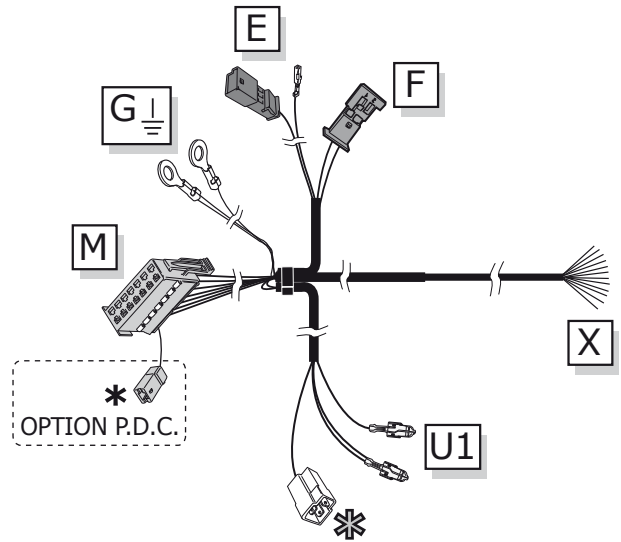
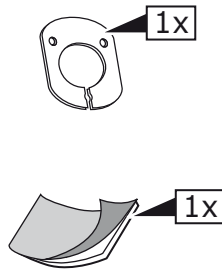
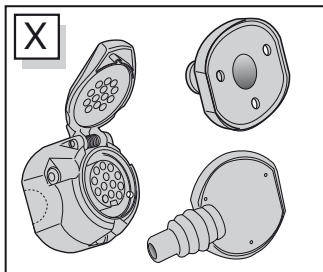
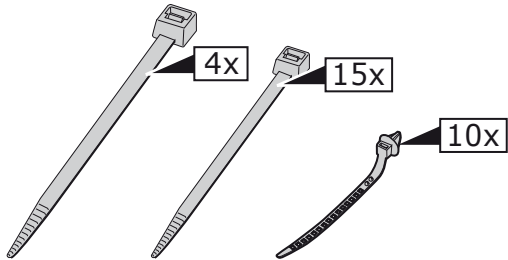
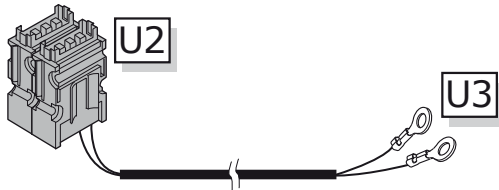
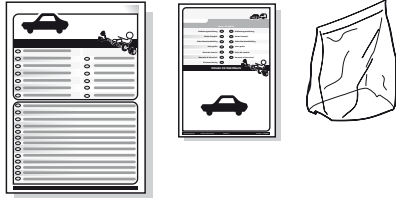
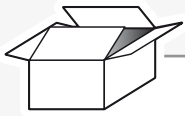

Option! *

PARK DISTANCE CONTROL

↓

PARK DISTANCE CONTROL

For not OEM P.D.C. System use the: VW-083-ZZ

*** OPTION +15**

preparation for

+15

Yellow

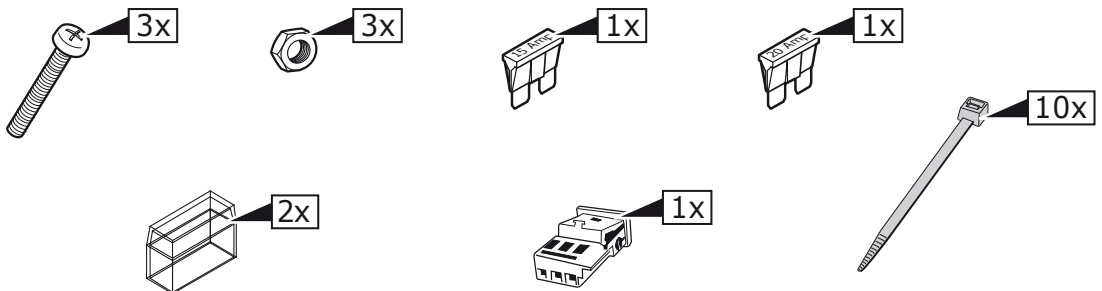

ROUTING

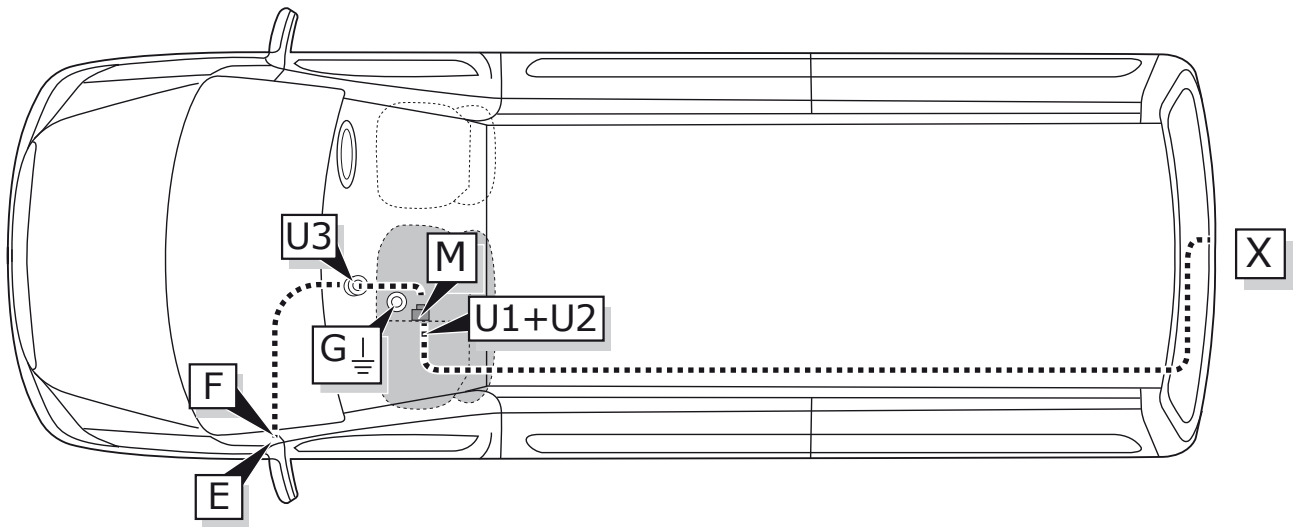

1

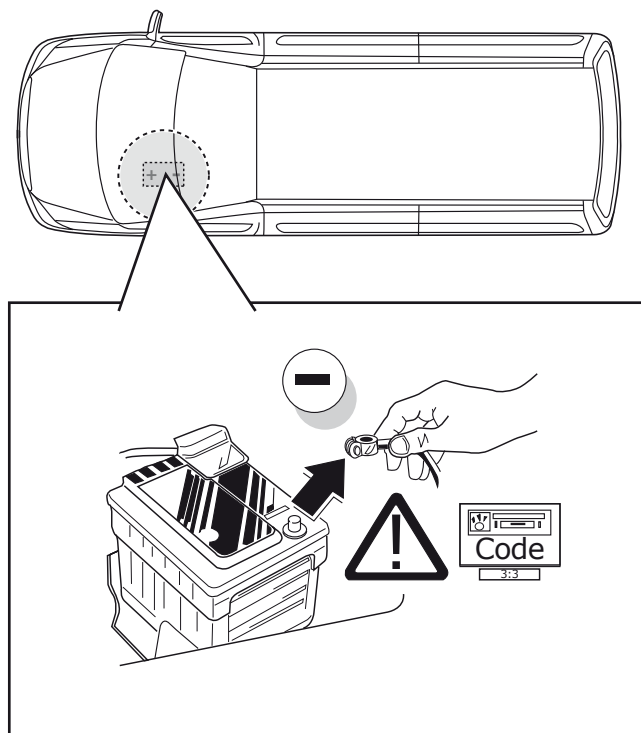

2

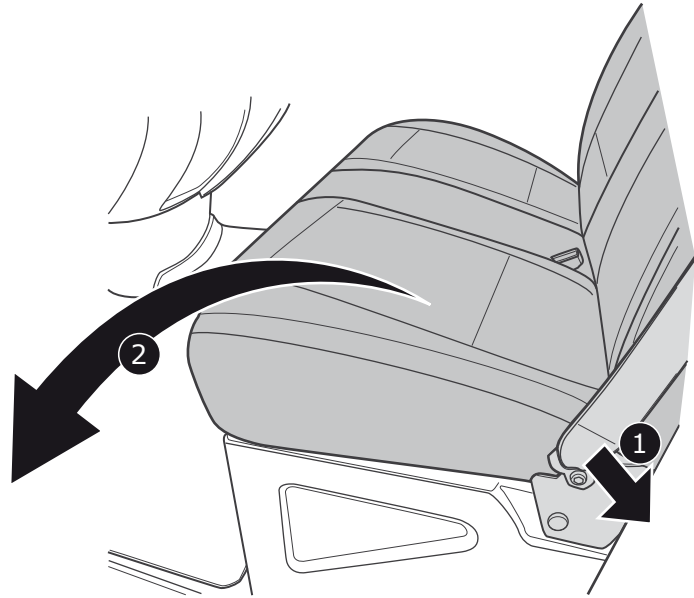
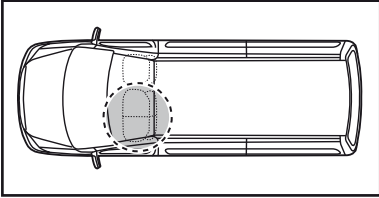

3

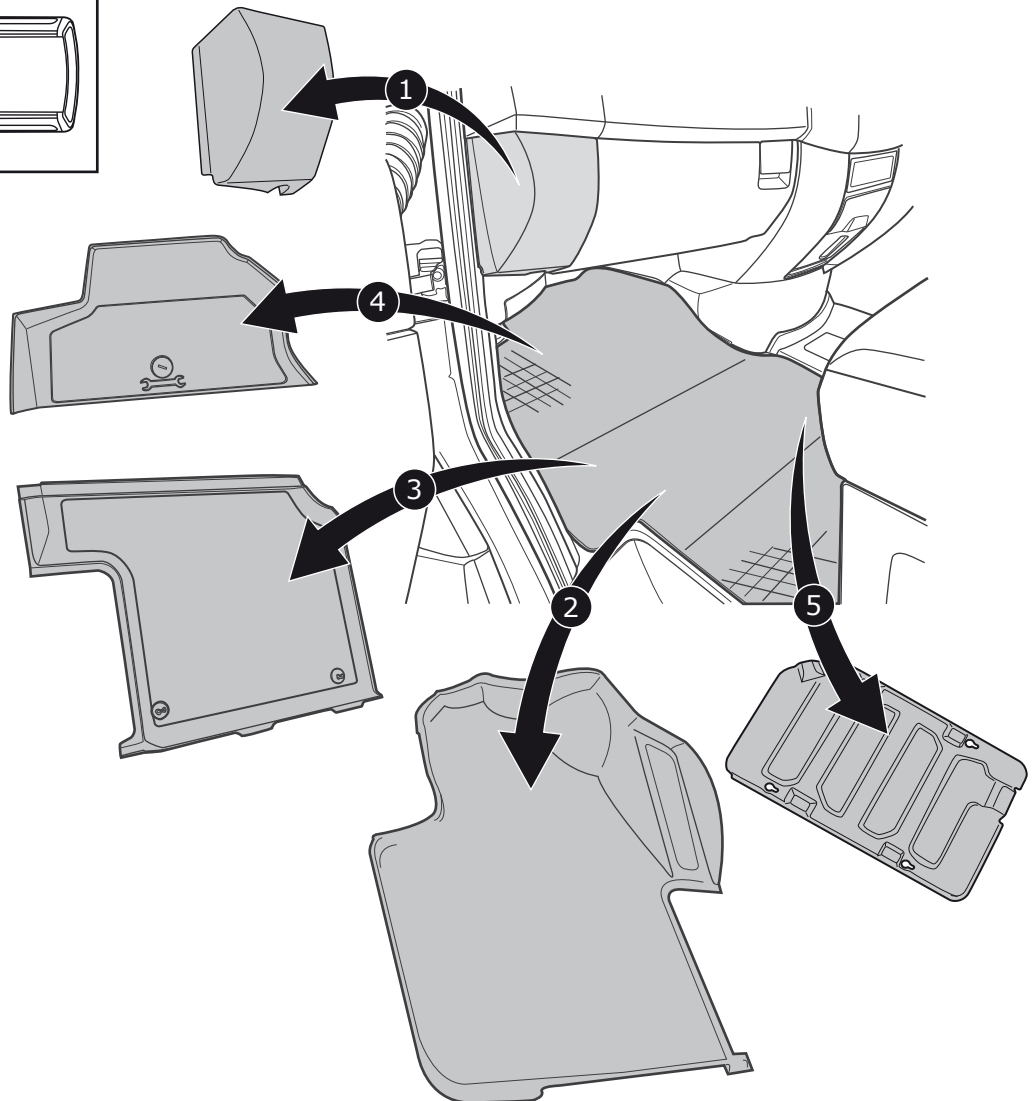
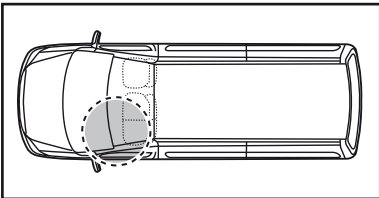

4

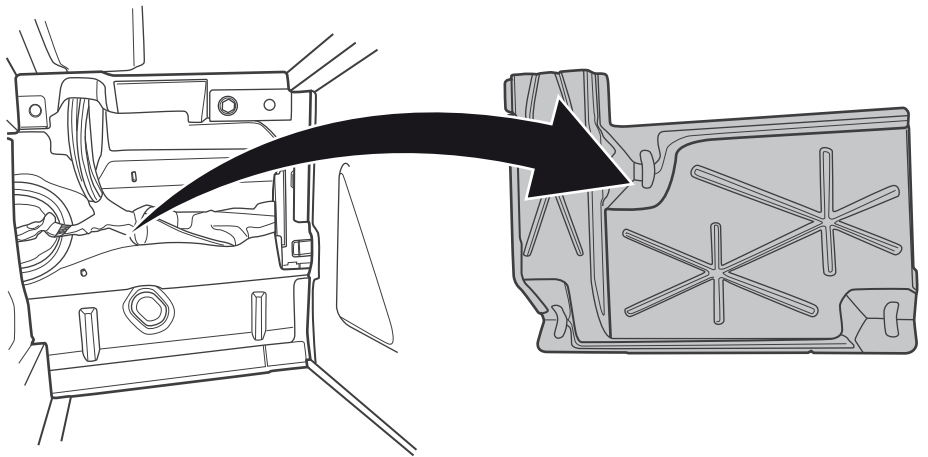
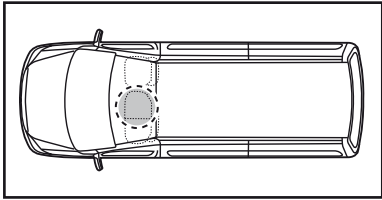

5

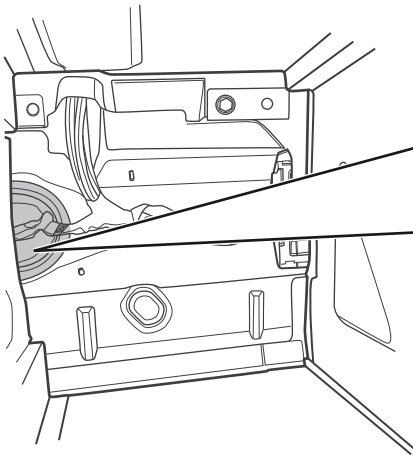

Underside

1

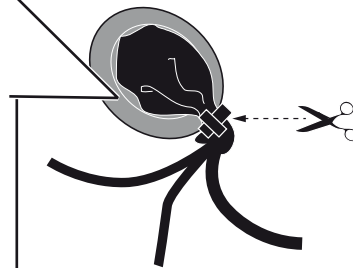

2

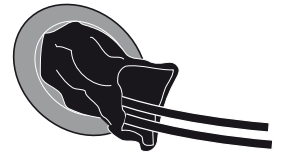

3

6

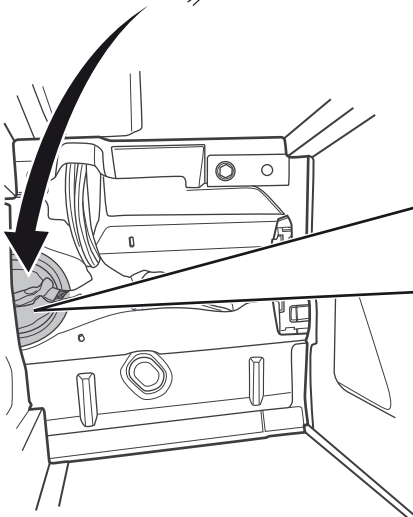
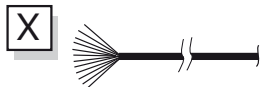

1



Underside

2

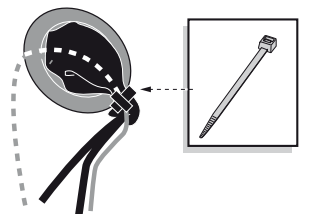

3

15x

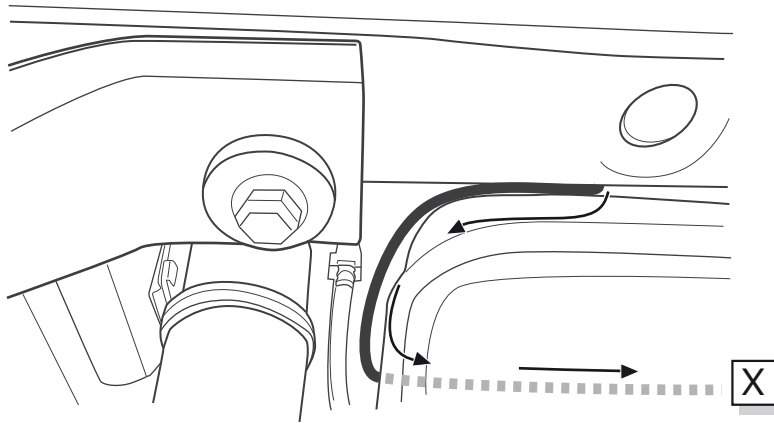
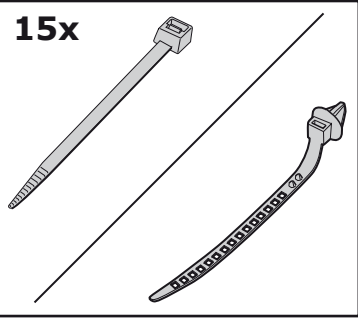

1

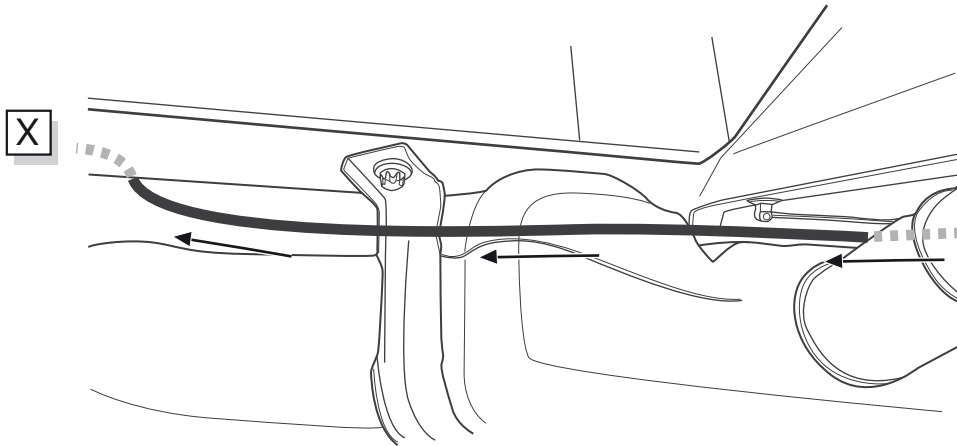

2

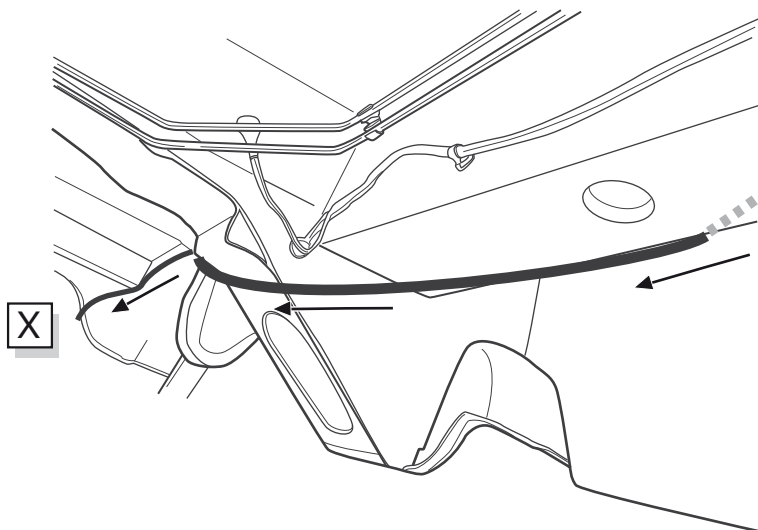

3

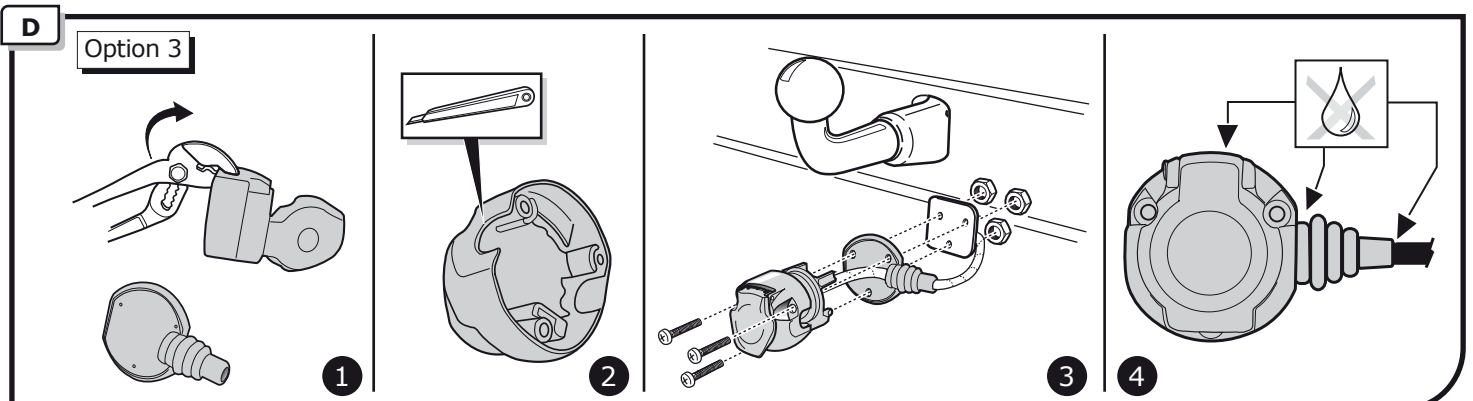
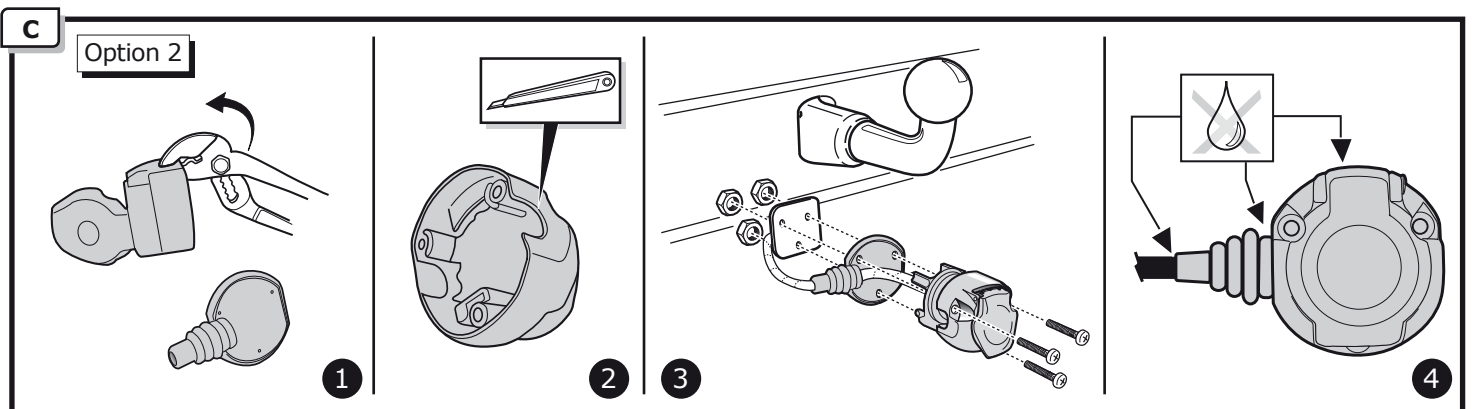
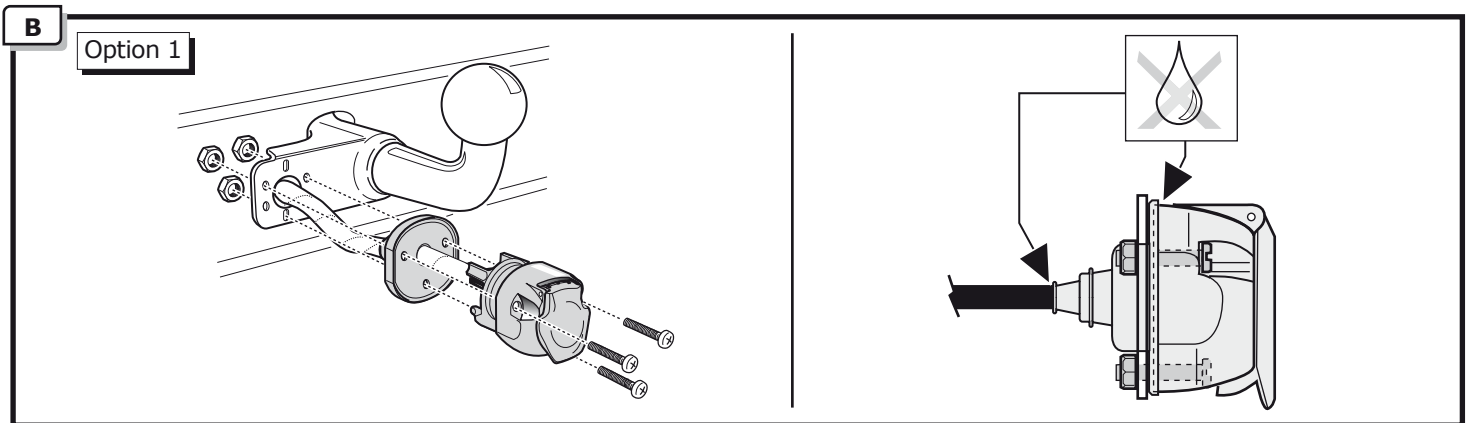
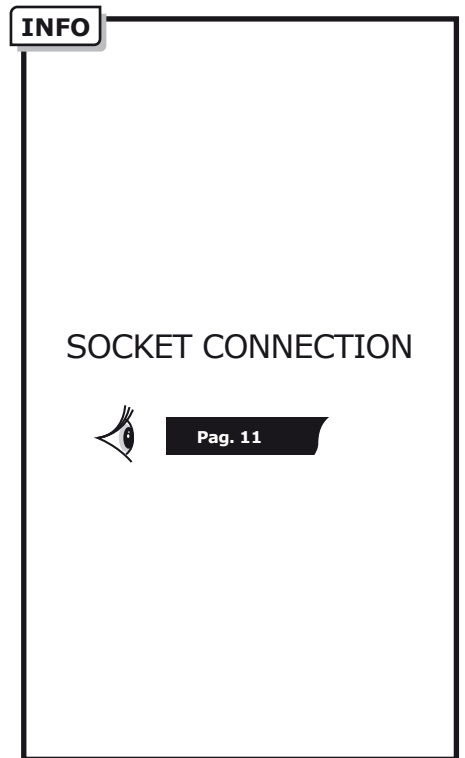
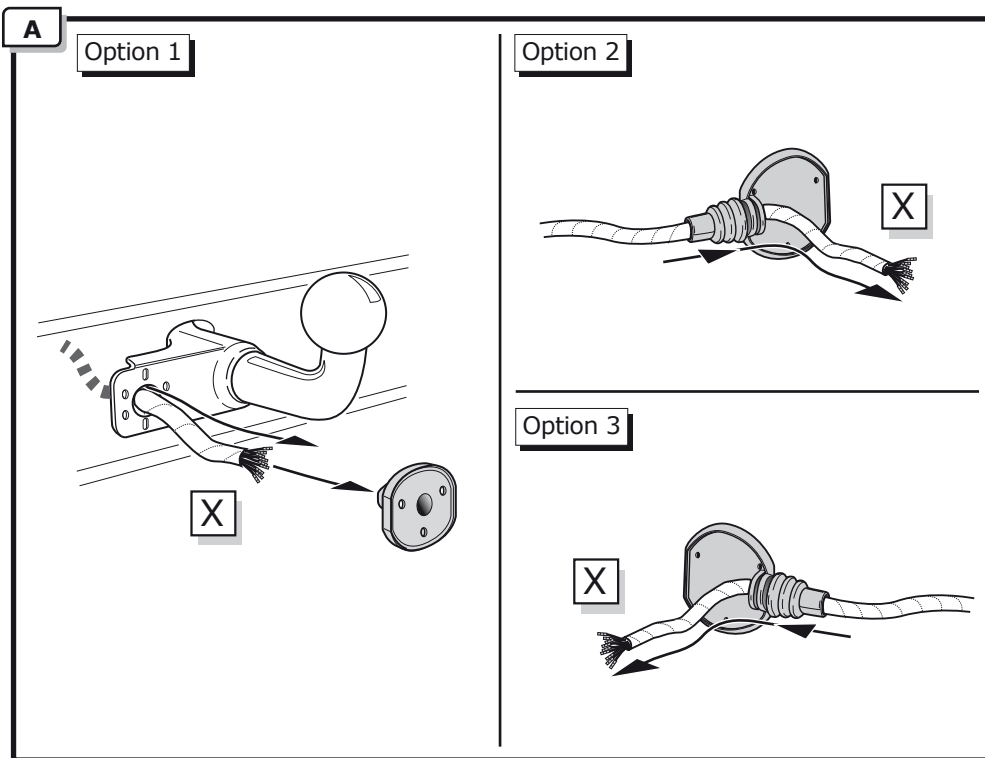

8

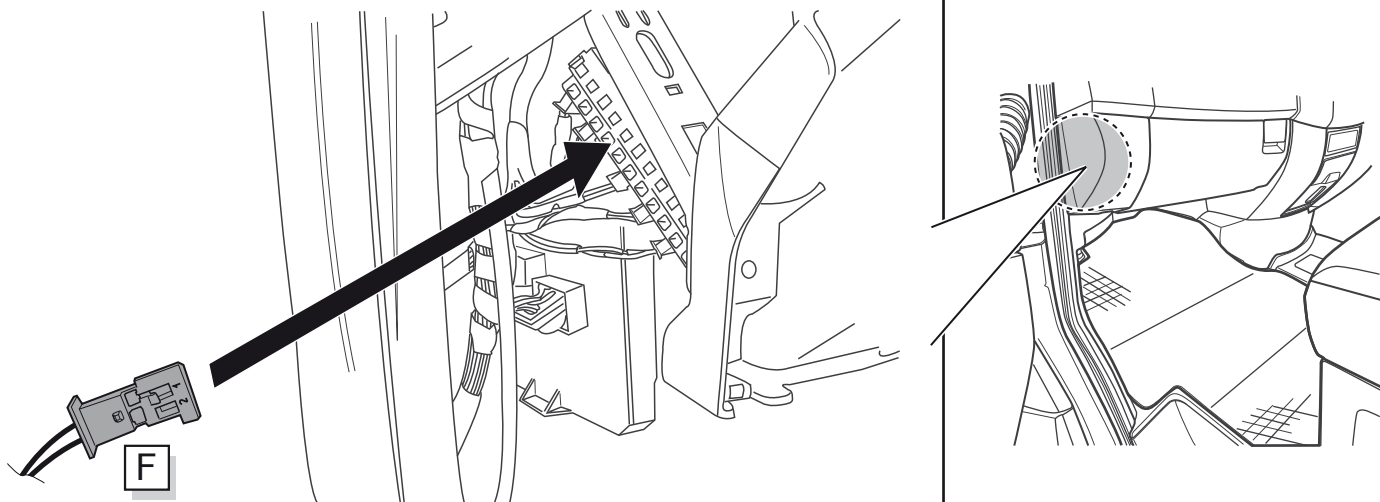

9

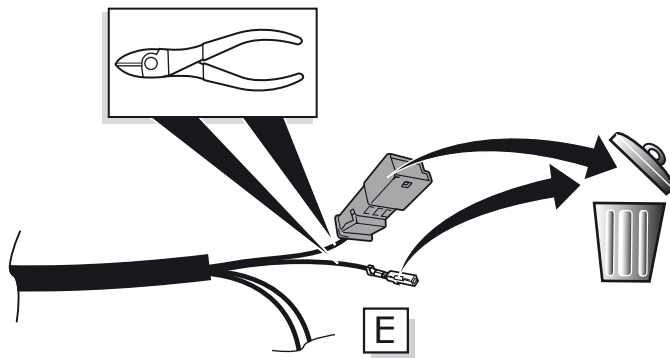

This connection is no longer needed.

1

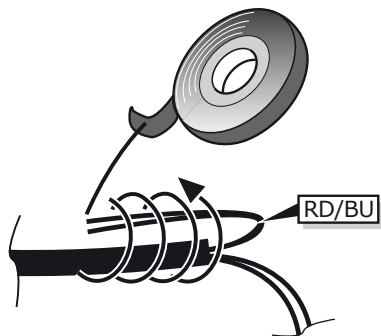

Please Isolate.

2

10

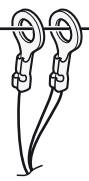
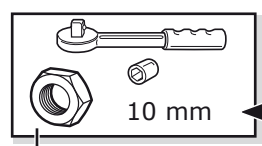
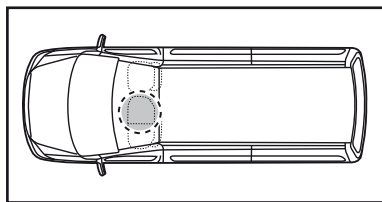

1

2

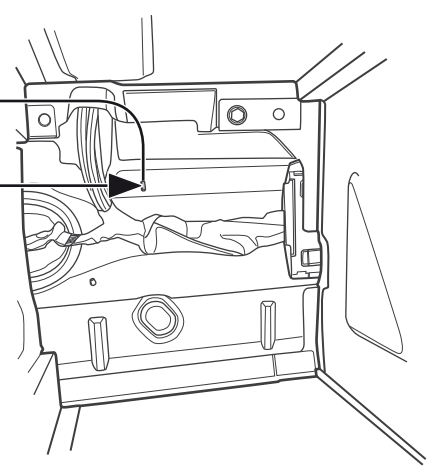

11

1

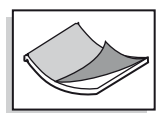
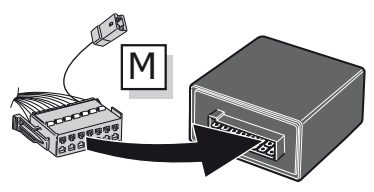

2

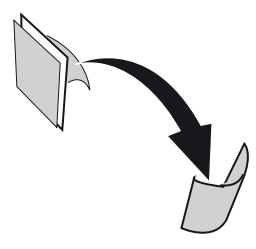

3

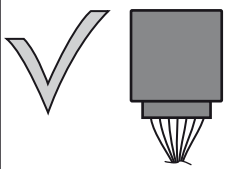
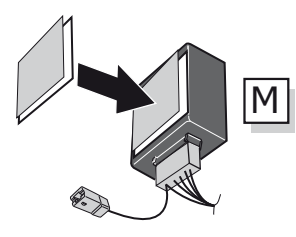

4

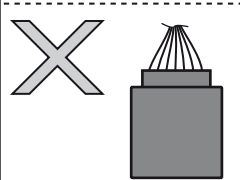
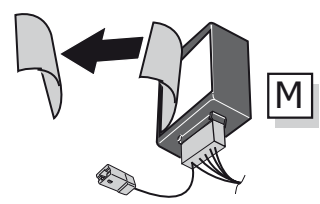

12

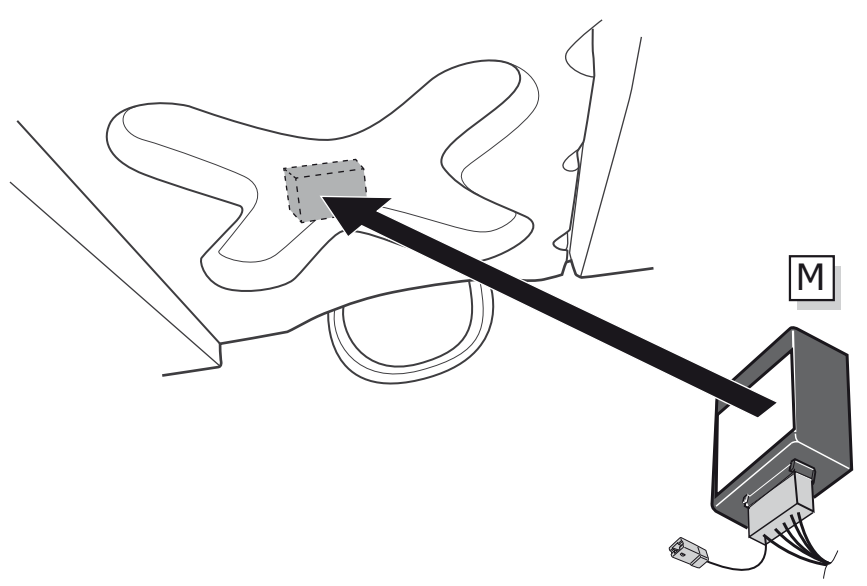
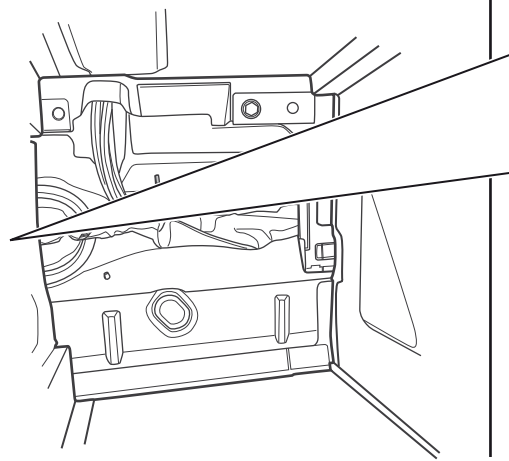
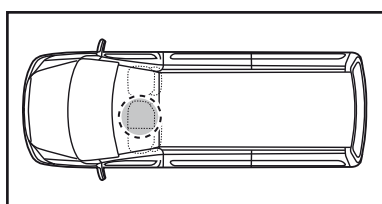

13

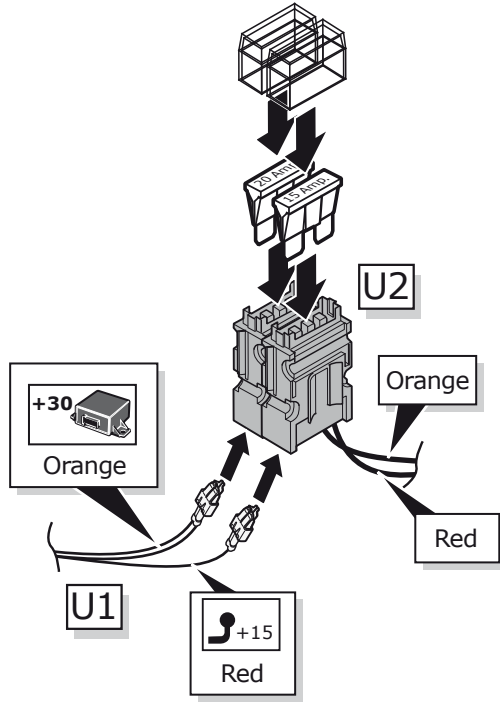
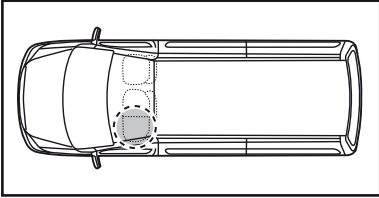

14

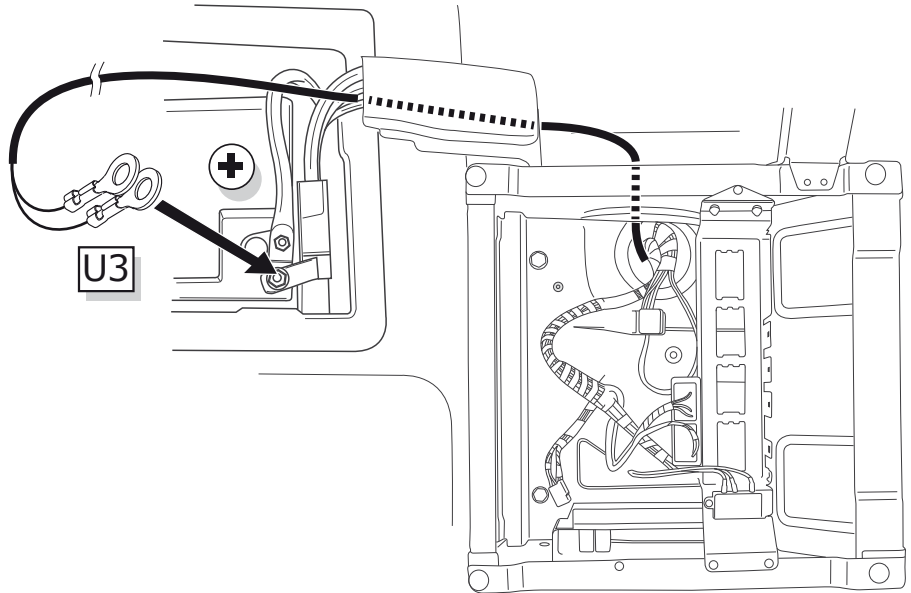
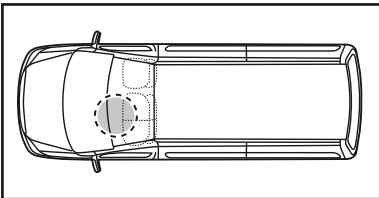

15

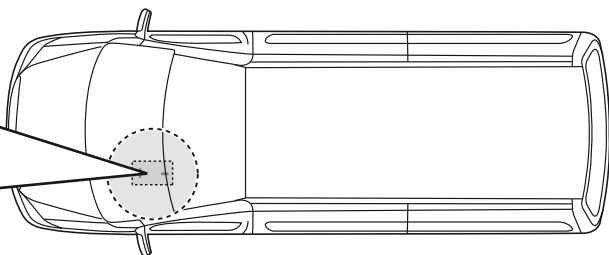
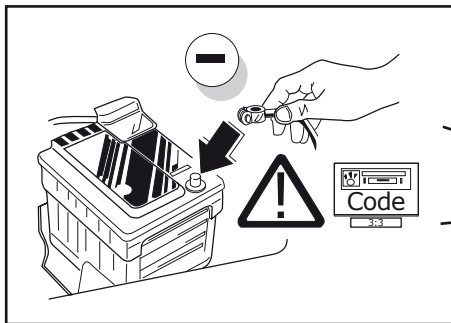



TEST ALL THE CIRCUITS WITH A TEST DEVICE WITH THE CORRECT POWER LOAD FOR EACH FUNCTION. A TEST DEVICE WITH LED'S CANNOT BE USED FOR THIS PURPOSE.

INFO

REINSTALL TRIM.

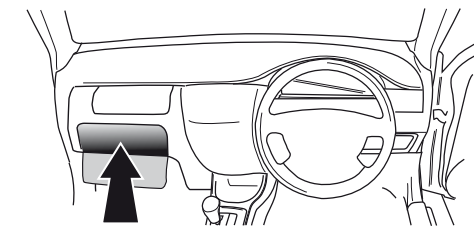

User guide



INFO

SOCKET CONNECTION

DIN/ISO 11446													
	1/L	2	3/31	4/R	5/58-R	6/54	7/58-L	8	9	10	11	12	13
Pmax	21W	21W		21W	42W	3x21W	42W	21W	180W/15Amp	180W/15Amp			
Colour	Black/White	Blue	Brown	Black/Green	Grey/Red	Black/Red	Grey/Black	Black	Red	Yellow	Brown	-	Brown